

ESTIMATION OF FLOW RATE THROUGH ANALYSIS OF PIPE VIBRATION

Santhosh K. VENKATA, Bhagya R. NAVADA

Department of Instrumentation and Control Engineering, Manipal Institute of Technology,
 Manipal Academy of Higher Education, Manipal 576104, India.

kv.santhu@gmail.com, kbgagya@gmail.com

received 9 September 2018, revised 15 December 2018, accepted 19 December 2018

Abstract: In this paper, implementation of soft sensing technique for measurement of fluid flow rate is reported. The objective of the paper is to design an estimator to physically measure the flow in pipe by analysing the vibration on the walls of the pipe. Commonly used head type flow meter causes obstruction to the flow and measurement would depend on the placement of these sensors. In the proposed technique vibration sensor is bonded on the pipe of liquid flow. It is observed that vibration in the pipe varies with the control action of stem. Single axis accelerometer is used to acquire vibration signal from pipe, signal is passed from the sensor to the system for processing. Basic techniques like filtering, amplification, and Fourier transform are used to process the signal. The obtained transform is trained using neural network algorithm to estimate the fluid flow rate. Artificial neural network is designed using back propagation with artificial bee colony algorithm. Designed estimator after being incorporated in practical setup is subjected to test and the result obtained shows successful estimation of flow rate with the root mean square percentage error of 0.667.

Key words: Accelerometer, Estimation, Frequency Response, Flow Rate, Neural Network, Vibration

1. INTRODUCTION

Flow process loops are found in almost all kinds of process industry starting from petroleum to dairy, pharmaceutical, dye making, food and beverage industries and so on. Objective of these flow process is primarily to control flow rate or control secondary parameters like liquid level, temperature etc. Monitoring of the process is key requirement for obtaining the appropriate end product. To have a good monitoring system, obtaining information at each and every part of the process is essential. For measuring these parameters sensors are essential. A brief study is carried on, to understand various flow sensors.

A number of researchers have reported work in the area of measurement of flow some of those have been discussed below. Marick et al., (2014) have reported a method of flow measurement without disturbing the flow in a pipeline is. This consists of two gauges, one for measurement of static pressure and the other for online fluid pressure measurement. Difference between these two pressures were used to find the flow rate of the fluid. Measured pressure is converted into electrical quantity by using inductive transducer. A non-contact type flow rate measurement system is reported by Sinha et al. (2015). In this method, a Hall Effect sensor is used to measure the variation in flow rate. Hall probe was located on top of the rotameter thus change in movement of magnetic float influences output voltage of Hall Effect sensor. Based on these variations, flow rate was measured. An optical method of flow measurement is reported by Norgia et al. (2016), using a laser diode for observing the laser divergence. In this method, measurement of flow is based on Doppler shift due to particles present in the fluid and self-mixing ability of laser diode. A device for flow measurement using Bragg's grating is reported by Kirwan et al. (2016). In this method, movement of cantilever arm is meas-

ured due to fluid momentum flowing in round pipe elbow. Output of grating was shown highly associated to the flow rate through pipe and also was stated independent of temperature and static pressure. Measurement of fluid flow through a pipe using fringing field capacitors is reported by Liu and Wang (2016). Capacitors were arranged like a cap type structure around plastic pipe creating fringing capacitance inside the pipe. When fluid flows through pipe, change in capacitance was observed which was directly projecting change in flow rate. Flow measurement in wind tunnel using a piezo electric sensor is reported by Kim et al. (2017). Wind flow measurement based on dynamic stress measured on wind tunnel using Pitot tube and trip strips. Sensor was designed to be sensitive for shear stress developed and was insensitive to static stress developed due to whirlwind lift up. An algorithm for improvement in accuracy for measurement of open channel flow rate is reported by Agu et al. (2017). Open channel flow system was simulated and fluid flow rate was estimated based on fluid depth. Measurement of flow rate by weighing method using two tanks is reported by Jaiswal et al. (2017). Second tank was used for increasing the time of water collection for large collection of water for reducing the diverter error. Redundancy was also a factor for using two tanks in case of failure in working of the tank. Flow rate was calculated based on the total amount of water collected and the time to collect the water. Flow rate measurement in thermal power plant large pipelines using radiotracer method is reported by (Biswal et al. 2018; Pely and Fernandes, 2017). In this method, solution of radiotracer with known concentration is injected into large pipe with consistent rate for a pre expected time duration. At the down streams where radiotracer was mixed homogeneously, water samples were collected and based on the concentration of radiotracer, flow rate was measured. A fluid flow rate monitoring system using video-metering is reported by Lay-Ekuakille et al. (2014). This method can be used

where there is requirement of contactless measurement. Measurement of small fluid flow using electrochemical phenomenon is reported by Krejčí et al. (2017). This phenomenon requires electrochemical compound due to which this method is not used in practical applications. Santhosh and Roy (2016) reported a flow measurement technique using venturi, independent of variations in liquid type and pipe dimensions.

Researchers have also reported work in the area of indirect measurement of fluid flow few of which are reported here. A method for measurement of water consumption in a pipe was reported by Schantz et al. (2015). In this method an accelerometer for vibration measurement at the pipes was used based on which usage of water was detected. Vibration at the pipes was not only due to fluid flow it was also due to valve on and off function causing pressure change. Measurement of pressure induced by low velocity turbulent airflow is reported by Hobeck and Inman, (2015) using pressure probe. Pressure probes were constructed to measure high turbulent low velocity airflow with high sensitivity. Designed pressure probes were able to measure the air flow with a mean velocity of 0-12 m/s with a sensitivity of 0.064 mV/Pa. Estimation of flow rate at the input of a control valve in a flow system using an observer based soft sensor is reported by Navada et al. (2017). Observer is developed by using the measurement from an orifice placed to measure the flow rate at output of control valve. Development of a virtual sensor for measurement of flow rate in the pipes by using mathematical models is reported by Malan et al. (2017). A mathematical model between flow rate and head loss was found by measuring state of the valves and flow rate at the inlet. For estimating flow rate through heat body, Hardy cross type algorithm was used. Measurement of fluid flow rate by observing the vibrations of fluid pipe was reported by Dinardo et al. (2018). In this paper, authors have considered the root mean square value of the vibration signal and the variation of this parameter was related to fluid flow rate and was concluded to be proportional.

Some of the research in the area of vibration measurement is described in this section. Measurement of amplitude of micro vibration using optical interferometers was reported by Yasuda et al. (2015). In this method, two beams were used one as reference and the other reflected from vibrating body. Wave reflected from vibrating body generates an interference signal whose number of amplitude peaks was proportional to vibration amplitude. A Bragg's grating sensor for measurement of vibration is reported by Guozhen et al. (2016). Based on the frequency response of the grating acceleration sensor, vibration was measured. A non-contact method for measurement of vibration using binocular vision sensor and piezoelectric actuators was reported by Qiu et al. (2018). In this paper, it was reported that binocular sensor was giving good performance for measurement of low frequency vibration and structural displacement at multiple points. Tracking of rotating object vibration using image processing technique was reported by Kim et al. (2015). In this method, image sensor was used to track the position of the laser beam and landmark on rotating object to obtain the vibration characteristics. An algorithm to measure the vibrations of a pump unit is reported by Koshekov et al. (2016) for analyzing the working of the pump. In this method, vibration signals were collected by placing sensors at different locations of pump unit. Vibration speed root mean square value was considered for gathering the information regarding the pattern of vibration signals. A non-contact method of vibration measurement is reported by Lezhin et al. (2017) for high pressure engine. In this method, use of one dimension vibrometer for obtaining the

details of engine surface vibration is reported and also compared with other two methods. Measurement of vibration displacement from a remote location using camera is reported by Son et al. (2015). This approach was suggested to use in the areas where measurement of vibrations are difficult to measure in location. Displacement was measured using edge detection technique and by taking second derivative of image. This method was reported to be better compared to other method as there was possibility of vibration measurements at multiple points. Mozuras (2017) reported a technique for measurement of high noisy vibration signals using a nonlinear converter. A monotonic nonlinear converter was used to get the vibration signals whose spectral components were found using Fourier transform. Measurement of structural vibration using optic electronic sensor is reported by Qiu and Lau, (2018). Measurement of propagation of surface vibrations in the ground using accelerometer is reported by Czech and Gosk, (2017). In this paper, accelerometers were mounted in the ground in four different ways and out of them ring mounting method was reported as the reliable method. A battery less sensor for measurement of vibrations induced in the rotating shafts of large ships was reported by Lee et al. (2018). Magnetostrictive principle was used to measure the vibrations induced due to high speed rotations. These sensors were used due to their healthy working nature under harsh environments. An ultrasonic stroboscope for measurement of underwater vibrations was reported by Luo et al. (2014). Authors have reported that this method was able to get the online information regarding the underwater vibrations. A cantilever underwater was used to test the sensor and it was compared with the traditional sensors. This sensor was not sensitive to the environmental changes and the major advantage was that it was a non-contact type of measurement.

From the survey it is evident that, flow is measured by a number of ways and head type or obstruction flow meters form a larger part of available measurement techniques. In the head type flow meters, measurement of flow is based on measurement of pressure difference created due to obstruction in the flow. But it is seen from the reported work that output of these sensor invariably vary with position at which sensor is placed. Characteristics of sensor often depend on liquid composition. So, in the proposed work a non-contact technique independent of liquid characteristics is presented.

2. EXPERIMENTAL SETUP

The experimental setup involves a simple flow process system consisting of reservoir, pneumatic actuators and flow meters as depicted in Fig. 1. P and I diagram of the flow process system is shown in Fig. 2. Solid lines connecting the blocks represent the flow of fluid, dash lines represent the electric signal in terms of current and dotted line represents the air pressure. Process consists of a reservoir tank from which water is pumped. Water flows along the path, where a control valve, rotameter and orifice plate are placed before returning back to reservoir. Rotameter shows the rate of fluid flowing out of control valve. A differential pressure transmitter (DPT) is mounted to measure the pressure difference created by the orifice plate towards the flow. Pressure difference across the orifice is measured and is represented in terms of mV voltage by pressure transmitter. Air to open type equal percentage control valve with a 3/4-inch valve opening is placed between pump and rotameter to vary the flow rate. Pneumatic actuator consists of a current to pressure converter, a diaphragm, upper

and lower pressure chamber, spring and valve stem. User input current of 4-20mA range is applied to current to pressure converter, which converts it into 3-15psi range of pressure which is applied on the lower chamber of the control valve. Once the applied pressure on lower chamber is more than upper chamber, diaphragm moves up causing valve to open leading to increase in output flow rate. When the pressure in lower chamber is less than the upper chamber, then spring brings valve stem to close position causing no fluid to flow out of control valve. A bypass valve is provided near the pump to provide returning path for the flow when the control valve is fully shut. Flow rate at the output of control valve is mainly based on the position of valve and also fluid flow rate at the inlet of control valve.



Fig. 1. Flow process setup

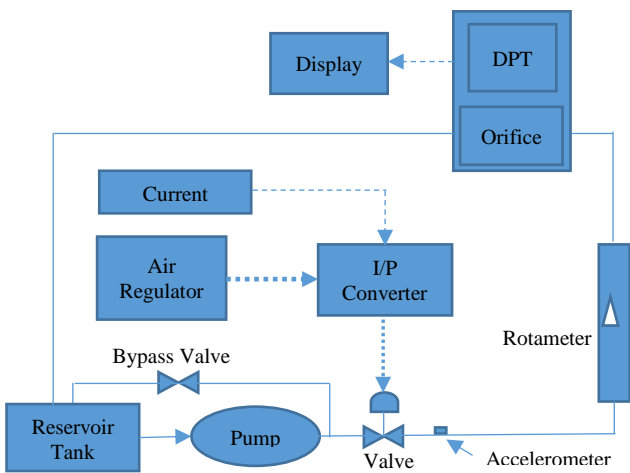

Fig. 2. P&I diagram of flow process system

3. STATEMENT OF OBJECTIVE

To understand the existing flow measurement technique using orifice flow meter, tests are carried out. Performance of the sensor is analyzed when the orifice hole diameter is varied and liquid is varied. The characteristics of the orifice flow meter is understood with the help of Bernoulli's equation given below).

$$\text{Flow rate: } Q = \frac{C \cdot A_{th} \cdot \sqrt{\frac{2 \cdot \Delta P}{\rho}}}{\sqrt{1 - b^4}} \text{ lph} \tag{1}$$

where: C – is the coefficient, A_{th} – Cross section area at orifice hole, b – Ratio of orifice hole and pipe diameter, ρ – density of liquid, ΔP – difference in pressure

Pressure difference for varying flow under different beta 'b' is plot in Fig. 3. In the present study, a pipe diameter is considered to be 1 inch and orifice hole diameter is 0.5, 0.65 and 0.4 inches, flow is varied in the range of 0 to 1800 lph.

Similar tests are conducted by varying liquid density and the plot for the same is shown in Fig. 4.

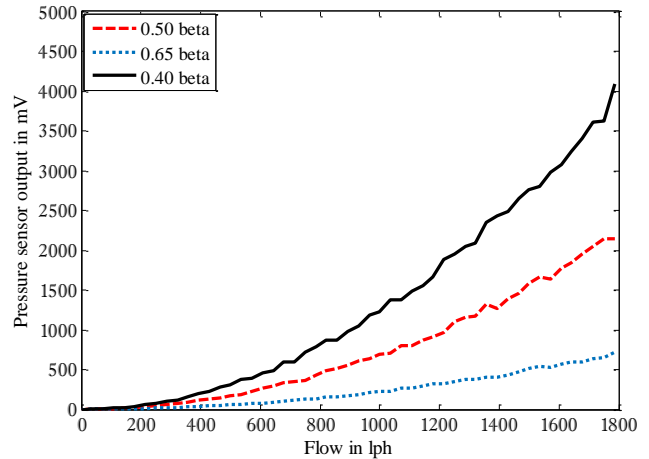

Fig. 3. Variation of flow transmitter characteristics with 'b'

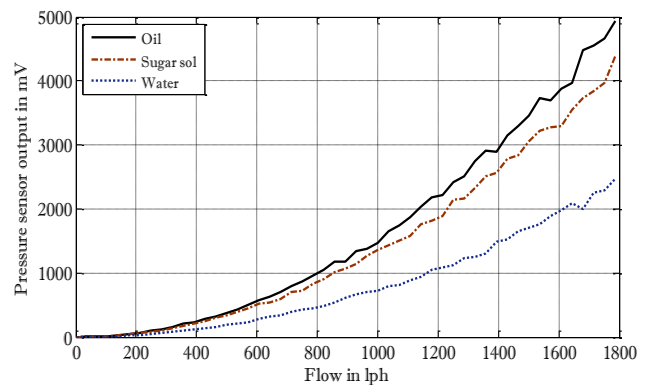

Fig. 4. Variation of flow transmitter characteristics with 'fluid density'

From the above graph and equations, it is clear that the present measurement technique involving head type flow meters like orifice, venturi, etc. or electromagnetic flow meters or rotameter would get effected by the placement of sensor. These meters would cause an impediment to the flow characteristics inside the pipe and if any physical faults occurs to these sensor, replacement of these is very tedious and need to be performed by authorized personnel only. So a technique is proposed in this paper which will measure the liquid flow without having contact with the flow and also would not pose any effect to flow characteristics.

4. METHODOLOGY

To achieve the objective discussed in the previous section it is essential to measure the flow rate using secondary sensor. Secondary sensor (accelerometer) data is used to estimate the flow rate in the proposed work. The vibration sensor is coupled on to

the pipe surface. In the proposed work, single axis accelerometer with a sensitivity of 9.8mV/g is mounted on pipe at the outlet of the pneumatic control valve, as shown in Fig. 5.



Fig. 5. Mounting of Accelerometer

Vibration data from the accelerometer is passed through an analog amplifier which is further acquired on to a computer using the data acquisition card. In the proposed work compact RIO of National Instruments is used to acquire the signal. Acquired data from the accelerometer is represented in Fig. 6 and Fig 7 for flow rates 1800 lph and 100 lph respectively.

To further analyze the signal, a band pass filter is designed. Filter is designed so as to reduce harmonics in the signal. Band pass filter is designed using the Sallen-Key architecture (Zin Ma Ma Myo et al. 2009) as given in below.

$$\text{Transfer function, } (s) = \frac{\frac{K_i a s}{P_i}}{\left[1 + \frac{as}{P_i} + (as)^2\right]} \cdot \frac{\frac{K_i a s}{P_i}}{\left[1 + \frac{1}{P_i} \left(\frac{s}{a}\right) + \left(\frac{s}{a}\right)^2\right]} \quad (2)$$

A fourth order equation is considered, with 'K_i' as the gain at the mid frequency, 'f_i' of each filter. 'P_i' is the pole quality of each filter, 'B' is the filter coefficient. 'a' and '1/a' are the mid frequencies of individual filters.

$$\text{Gain at } f_i: K_i = \frac{B}{3-B} \quad (3)$$

$$\text{Filter quality } P_i = \frac{1}{3-B} \quad (4)$$

Output obtained after performing the filtering operation is shown in Fig 8 and Fig 9.

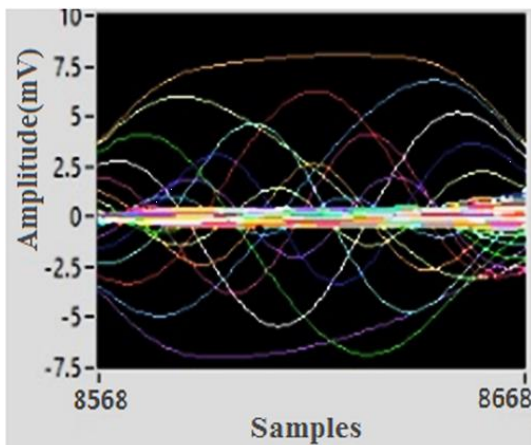

Fig. 6. Accelerometer signal for flow of 1800 lph

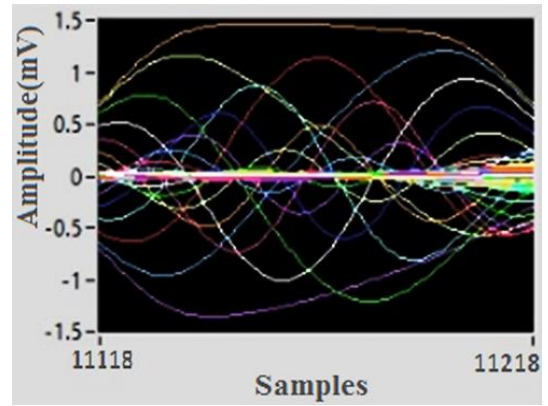

Fig. 7. Accelerometer signal for flow of 100 lph

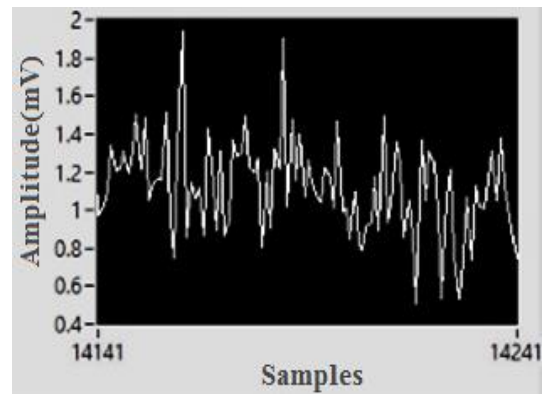

Fig. 8. Filtered output for flow of 1800 lph

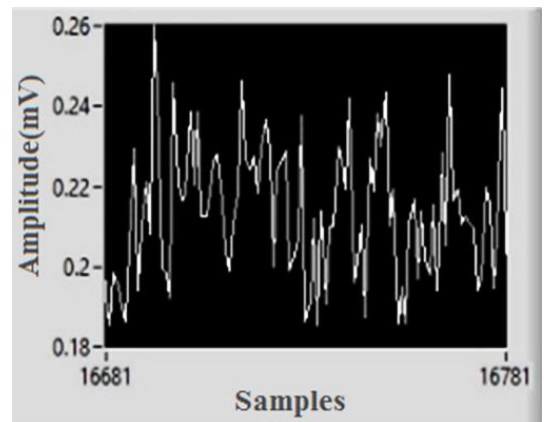

Fig. 9. Filtered output for flow of 100 lph

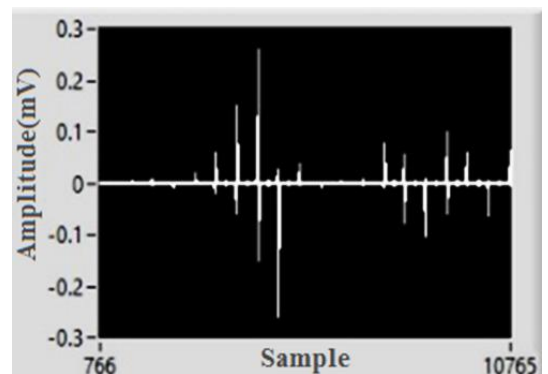

Fig. 10. Fourier transform output for flow of 1800 lph

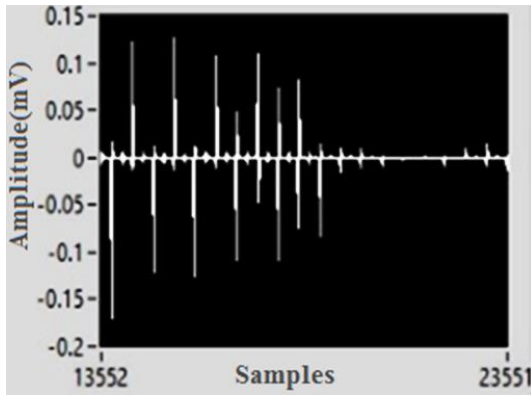

Fig. 11. Fourier transform output for flow of 100 lph

Fourier transform of the filtered signal is obtained so as to derive a magnitude function relating to flow rate. Fourier transform signal obtained for the flow of 100 lph and 1800 lph is shown in Fig. 10 and Fig. 11 respectively. The obtained Fourier transform signal is used to estimate the flow rate using neural network algorithm. For training the neural network is fed with input data and target data. Learning of neurons is achieved by varying the weighted function and activation function. Various algorithms had been presented in literature to varying the values of weighted function like Levenberg–Marquardt algorithm, genetic algorithm, artificial bee colony algorithms, ant colony optimization, etc. In the proposed work artificial bee colony algorithm is used to train the weights.

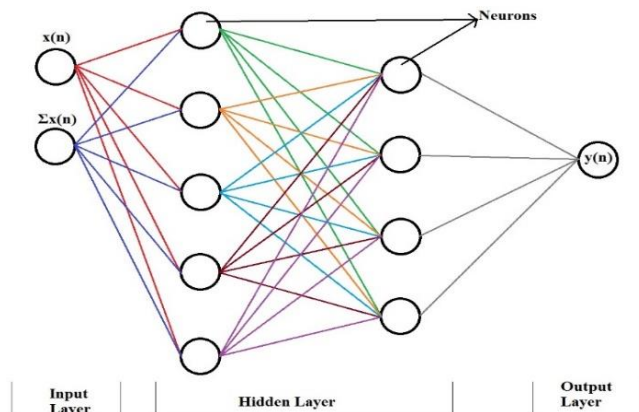

Fig. 12. Structure of neural network

Tab.1. Neural network parameters

Training data	2x86	60%
Validation data	2x29	20%
Test data	2x29	20%
Input layer	2 neurons	
Hidden layers	5 neurons	
	4 neurons	
Output layer	1 neuron	
Activation function	Tanh	
Learning rate	0.03	
Regularization rate	0.1	

Neurons are clustered in various networks like linear network, back propagation network, radial basis function, etc. In the proposed work back-propagation network is implemented. The multi-

layer perceptron layer consisting of two hidden layers, one output and input layer is obtained. Output layer consists of a single neuron, hidden layers consists of five and four neurons. Input layer consists of two neurons which is subjected with Fourier transform signal and the normalized Fourier transform signal as shown in Fig 12. Neural network parameters obtained after training is shown in Tab. 1.

5. RESULTS AND ANALYSIS

Flow estimation technique designed using the accelerometer as sensor is tested and validated with standard available instrument. For testing flow rate is varied in the range of 0 to 1800 lph. The liquid under test is also varied to comprehend its performance of the designed system. Results obtained for the test conducted are shown in Tab. 2.

Tab. 2. Results obtained when tested with physical system

Actual flow (lph)	Estimated flow (lph)	Liquid type	% error
50	49.5	Water	1.00
150	151.2	Water	-0.80
400	401.5	Water	-0.38
510	513.6	Water	-0.71
650	648.2	Water	0.28
770	771.6	Water	-0.21
910	916.4	Water	-0.70
1000	997.2	Water	0.28
1180	1181.7	Water	-0.14
1320	1326.5	Water	-0.49
1510	1494	Water	1.06
1700	1721	Water	-1.24
350	351.8	Sugar solution	-0.51
480	484.8	Sugar solution	-1.00
610	607.4	Sugar solution	0.43
870	876.1	Sugar solution	-0.70
990	998.2	Sugar solution	-0.83
1250	1254.1	Sugar solution	-0.33
1470	1463.5	Sugar solution	0.44
1650	1662.3	Sugar solution	-0.75
1780	1776.4	Sugar solution	0.20

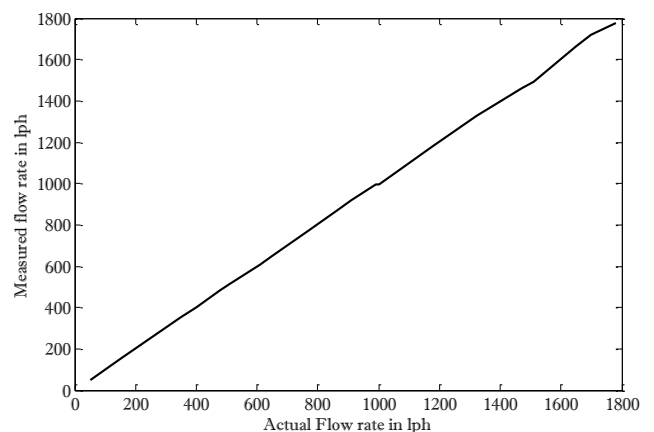

Fig. 13. Input output performance of proposed technique

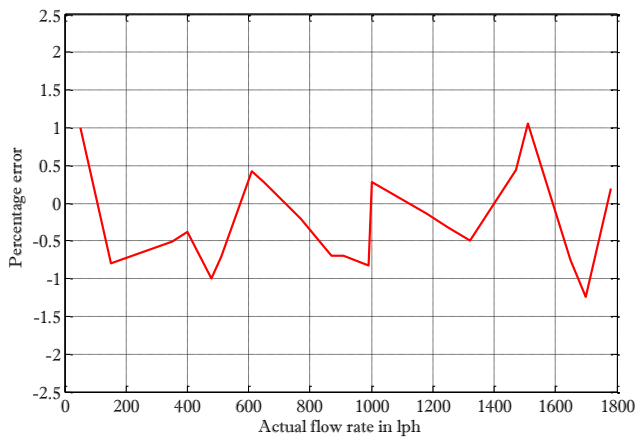

Fig. 14. Error performance of proposed technique

Performance of the presented work in estimating the flow rate of the liquid is represented in Tab. 2. It is observed that the flow rate is estimated accurately with maximum root mean square error of 1.24 %. Presented work is able to measure the flow rate indeterminate of fluid type within the maximum error of 21 lph without recalibrating the system for variation in fluid type. The plot of the error and input-output characteristics is depicted in Fig. 13 and Fig. 14. Characteristics shows linear behavior from the measurement system.

6. CONCLUSION

Flow measurement being one of the most widely used process in any industries, need to be highly precise and accurate. It is also expected that the system should be robust and needs less recalibration for variations in parameters. Available contact type measurement techniques often interrupt the behavior of flow and also needed to be recalibrated for changes in liquid type. Liquid flow estimation technique from the vibration analysis of the structure was designed with an objective of accurately measuring the flow rate even with changes in liquid type was fulfilled. The technique was designed by processing the signal from accelerometer in the stages of amplification, filtering, Fourier transform and neural network modeling. Performance of the trained system was analyzed using practical setup, and results shows successful implementation with a tolerable root mean square error of 0.67%.

From the characteristics displayed by the flow measurement system it is clear that, the instrument can be put in use for measurement of flow under harsh environment when the fluid parameter varies constantly.

REFERENCES

- Agu C.E., Hjulstad Å., Elseth G., Lie B. (2017), Algorithm with improved accuracy for real-time measurement of flow rate in open channel systems, *Flow Measurement and Instrumentation*, 57, 20-27.
- Biswal J., Pant H.J., Goswami S., Samantray J.S., Sharma V.K., Sarma K.S.S. (2018), Measurement of flow rates of water in large diameter pipelines using radiotracer dilution method, *Flow Measurement and Instrumentation*, 59, 194-200.
- Czech K.R., Gosk W. (2017), Measurement of surface vibration accelerations propagated in the environment, *Procedia engineering*, 189, 45-50.
- Dinardo G., Fabbiano L., Vacca G., Lay-Ekuakille A. (2018), Vibrational signal processing for characterization of fluid flows in pipes, *Measurement*, 113, 196-204.
- Guozhen Y., Yongqian L., Zhi Y. (2016), A novel fiber Bragg grating acceleration sensor for measurement of vibration, *Optik-International Journal for Light and Electron Optics*, 127(20), 8874-8882.
- Hobeck J. D., Inman D.J. (2015), Low-Cost Pressure Probe Sensor for Predicting Turbulence-Induced Vibration from Invasive Low-Velocity Turbulent Flow Measurements, *IEEE Sensors Journal*, 15(8), 4373-4379.
- Jaiswal S.K., Yadav S., Agarwal R. (2017), Design and development of a novel water flow measurement system, *Measurement*, 105, 120-129.
- Kim D., Khalil H., Nam J., Park, K. (2015), Image-based tracking system for rotating object vibration measurement using laser scanning vibrometer, *International Journal of Precision Engineering and Manufacturing*, 16(8), 1717-1721.
- Kim T., Saini A., Kim J., Gopalathnam A., Zhu Y., Palmieri F.L., Jiang X. (2017), Piezoelectric Floating Element Shear Stress Sensor for the Wind Tunnel Flow Measurement, *IEEE Trans. Ind. Electron*, 46, 1-1.
- Kirwan P.P., Creighton D., Costello C., O'Brien T.P., Moloney K.W. (2016), Momentum Change Flow Meter With Pressure Compensation Using FBGs, *IEEE Sensors Journal*, 16(19), 7061-7064.
- Koshekov K.T., Klikushin Y.N., Kobenko V.Y., Sofina N.N., Savostin A. A., Kashevkin A.A. (2016), Testing a pump unit by identification measurements of vibration signals, *Russian Journal of Nondestructive Testing*, 52(5), 280-286.
- Krejčí J., Ježová L., Kučerová R., Plička R., Broža Š., Krejčí D., Ventrubová I. (2017), The measurement of small flow. *Sensors and Actuators A: Physical*, 266, 308-313.
- Lay-Ekuakille A., Vergallo P., Griffo G., Morello R. (2014), Pipeline flow measurement using real-time imaging, *Measurement*, 47, 1008-1015.
- Lee J.K., Seung H.M., Park C.I., Lee J.K., Lim D.H., Kim, Y.Y. (2018), Magnetostrictive patch sensor system for battery-less real-time measurement of torsional vibrations of rotating shafts, *Journal of Sound and Vibration*, 414, 245-258.
- Lezhin D.S., Falaleev S.V., Safin A.I., Ulanov A.M., Vergnano D. (2017), Comparison of different methods of non-contact vibration measurement, *Procedia Engineering*, 176, 175-183.
- Liu Z., Wang W. (2016), Flow measurement method based on a fringing field capacitor structure, *Electronics Letters*, 52(21), 1771-1772.
- Luo Z., Chu J., Shen L., Hu P., Zhu H., Hu L. (2014), Measurement of underwater vibration by ultrasonic speckle stroboscopic technique. *Measurement*, 47, 938-945.
- Malan S., Greco C., Tisseur R., Bari F. (2017), Parameters Estimation of Hydraulic Circuit Head Losses for Virtual Sensor Design, *IEEE Transactions on Control Systems Technology*, 25(4), 1345-1358.
- Marick S., Bera S.K., Bera S.C. (2014), A modified technique of flow transducer using Bourdon tube as primary sensing element, *IEEE Sensors Journal*, 14(9), 3033-3039.
- Mozuras A. (2017), Vibration measurement with nonlinear converter in the presence of noise, *Journal of Sound and Vibration*, 407, 309-331.
- Navada B.R., Santhosh K.V., Mazhar A., Singh A.K., (2017), July. Design of Kalman observer for estimation of in-flow, *International Conference on Intelligent Computing, Instrumentation and Control Technologies (ICICT)*, 1010-1014),
- Norgia M., Pesatori A., Donati S. (2016), Compact laser-diode instrument for flow measurement, *IEEE Transactions on Instrumentation and Measurement*, 65(6), 1478-1483.
- Pecly J.O.G., Fernandes S.R.C. (2017), Ancillary device for flow rate measurement using dye tracer technique, *Flow Measurement and Instrumentation*, 54, 274-282.

24. **Qiu Q., Lau D.** (2018), Measurement of structural vibration by using optic-electronic sensor, *Measurement*, 117, 435-443.
25. **Qiu Z.C., Wang X.F., Zhang X.M., Liu J.G.** (2018), A novel vibration measurement and active control method for a hinged flexible two-connected piezoelectric plate, *Mechanical Systems and Signal Processing*, 107, 357-395.
26. **Santhosh K.V., Roy B.K.** (2016), A Practically validated intelligent calibration circuit using optimized ANN for flow measurement using venture, *Jr. of The Institution of Engineers (India): Series B*, 97 (1), 31-39.
27. **Schantz C., Donnal J., Sennett B., Gillman M., Muller S., Leeb, S.** (2015), Water nonintrusive load monitoring, *IEEE Sensors Journal*, 15(4), 2177-2185.
28. **Sinha S., Banerjee D., Mandal N., Sarkar R., Bera S.C.** (2015), Design and implementation of real-time flow measurement system using Hall probe sensor and PC-based SCADA, *IEEE Sensors Journal*, 15(10), 5592-5600.
29. **Son K.S., Jeon H.S., Park J.H., Park J. W.** (2015), Vibration displacement measurement technology for cylindrical structures using camera images, *Nuclear Engineering and Technology*, 47(4), 488-499.
30. **Yasuda A., Hasegawa S., Pohtala J.V., Miyazaki T.** (2015), Amplitude measurement of micro-vibration with robust optical interferometer systems, *Optik-International Journal for Light and Electron Optics*, 126(23), 4577-4580.
31. **Zin M.M.M., Zaw M.A., Zaw M.N.** (2009), Design and Implementation of Active Band-Pass Filter for Low Frequency RFID (Radio Frequency Identification) System, *Proceedings of the International Multi Conference of Engineers and Computer Scientists, Hong Kong*.